

남일벨트시스템

하바지트(Habasit) 제품 카탈로그

섬유 산업 컨베이어 벨트

제품 개요

방적·연사·권취 등 섬유 공정에 사용되는 고속·정밀 구동 벨트입니다. 에너지 절감형 스펀들 테이프도 포함됩니다.

주요 특징

- 방적·연사·권취 공정용
- 고속·정밀 구동에 최적
- 에너지 절감형 스펀들 테이프
- 내마모성·대전방지 옵션

남일벨트시스템 (Namil Belt System) | 하바지트(Habasit) 공식 파트너

대표: 홍중수 | 사업자등록번호: 268-06-02265 | 서울시 동대문구 한천로2길 16, 212호(덕암빌딩)

전화: 02-6084-7795 | 이메일: namilsystem@naver.com | 홈페이지: namilbeltsystem.github.io

Textile Industry

Power Transmission and Conveyor Belts for Yarn Processing



Introduction	3
Process overview	4
Yarn manufacturing and blow room	4
Ring spinning for carded yarn	6
Ring spinning for combed yarn	8
OE spinning	10
HabaDRIVE® power transmission belts	12
Energy savings with HabaDRIVE® power transmission belts	15
Habasit spindle tapes	17
Energy savings with Habasit spindle tapes	19
Application table	20
Solutions in motion	22
Contacts	24



Innovation is a key word at Habasit

Yarn manufacturing requires a wide range of power transmission belts, spindle tapes and conveyor belts. Habasit's extensive offering allows customers to choose the best product for their application. The focus of all our developments is on increased service life, higher reliability, reduced energy consumption, and improved price/value ratios.

Habasit works closely with leading machine manufacturers and end-user groups to ensure customer-oriented product and service developments that deliver high quality and fast time to market. For example: TC thermoplastic power transmission belts with polyester (PET) fabric as the traction layer.

Focus on yarn processing

Habasit is the leading belt manufacturer worldwide, offering a complete product range for all applications in the short- and long staple, as well as in the man-made fiber industries. From bale opening to winding and twisting.

The right solution for every application

Our extensive range of solutions enables our customers to choose the best product for their applications.

Competence and experience

Habasit's application engineers, technicians and joining specialists provide professional consulting, superb customer service and excellent support. Founded in 1946, Habasit has proven its understanding of customer needs for more than 70 years. With our extensive global network, Habasit is able to respond to any request that you may have with world-class, premium quality belting solutions tailored to your specific needs.



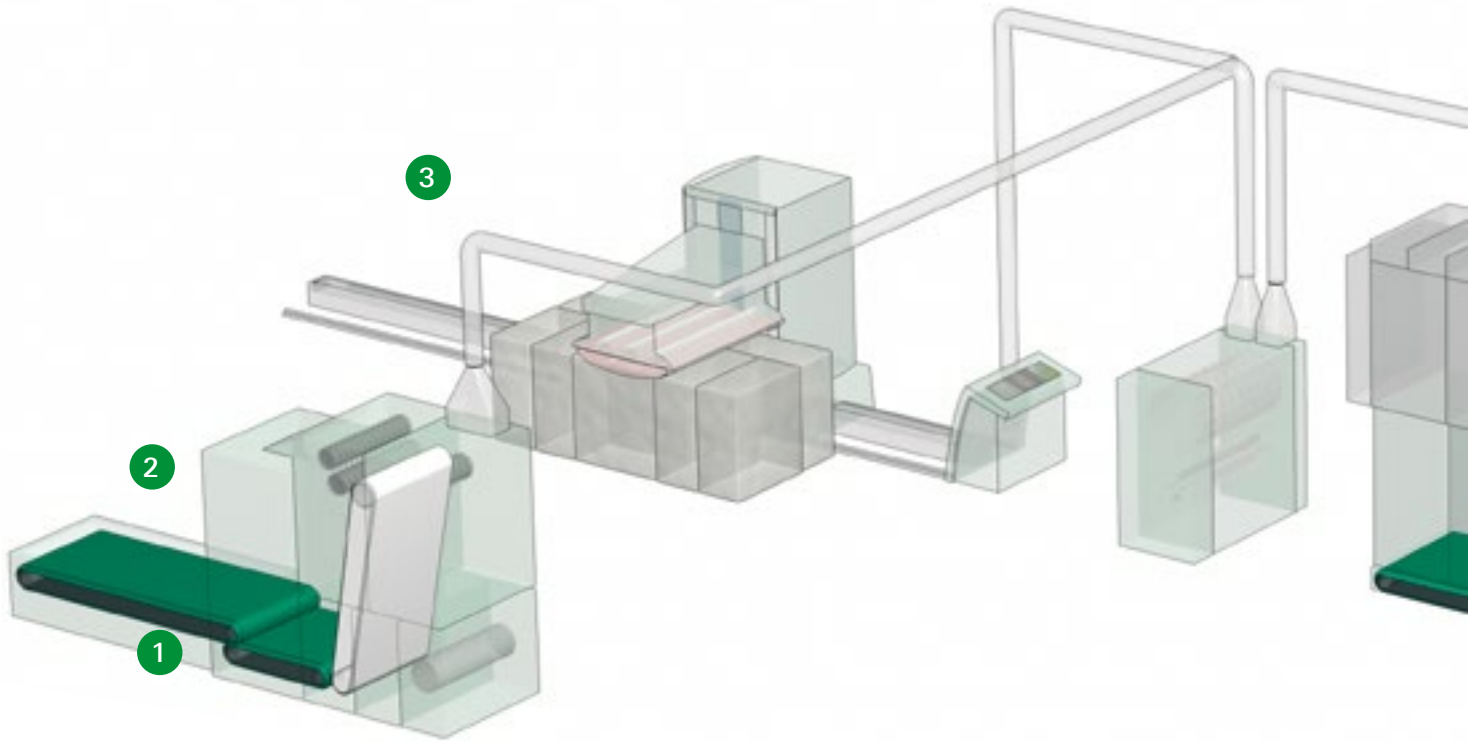

- | | |
|-------------------------|-------------------------------|
| 1 Feeder belt | 6 Spiked lattice |
| 2 Bale opener | 7 Cleaning and dedusting unit |
| 3 Automatic bale opener | 8 Card |
| 4 Blending opener | 9 Driving belt |
| 5 Feeder belt | 10 Card with cross apron |

These drawings show schematic examples of selected applications and processes, and are neither complete nor comprehensive. The belt recommendations (use/application/layout) can only be considered as a general suggestion. Due to the complexity of the various processes and technical requirements, and external influences such as the nature or properties of the transported goods, process speeds, stages of treatment/handling, environmental or process temperatures, humidity, chemicals, additives, ingredients, and recipes, etc. there are many possible solutions.



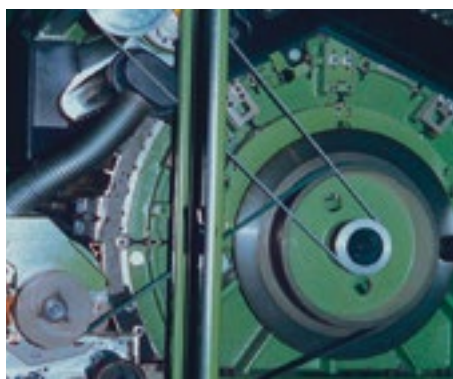
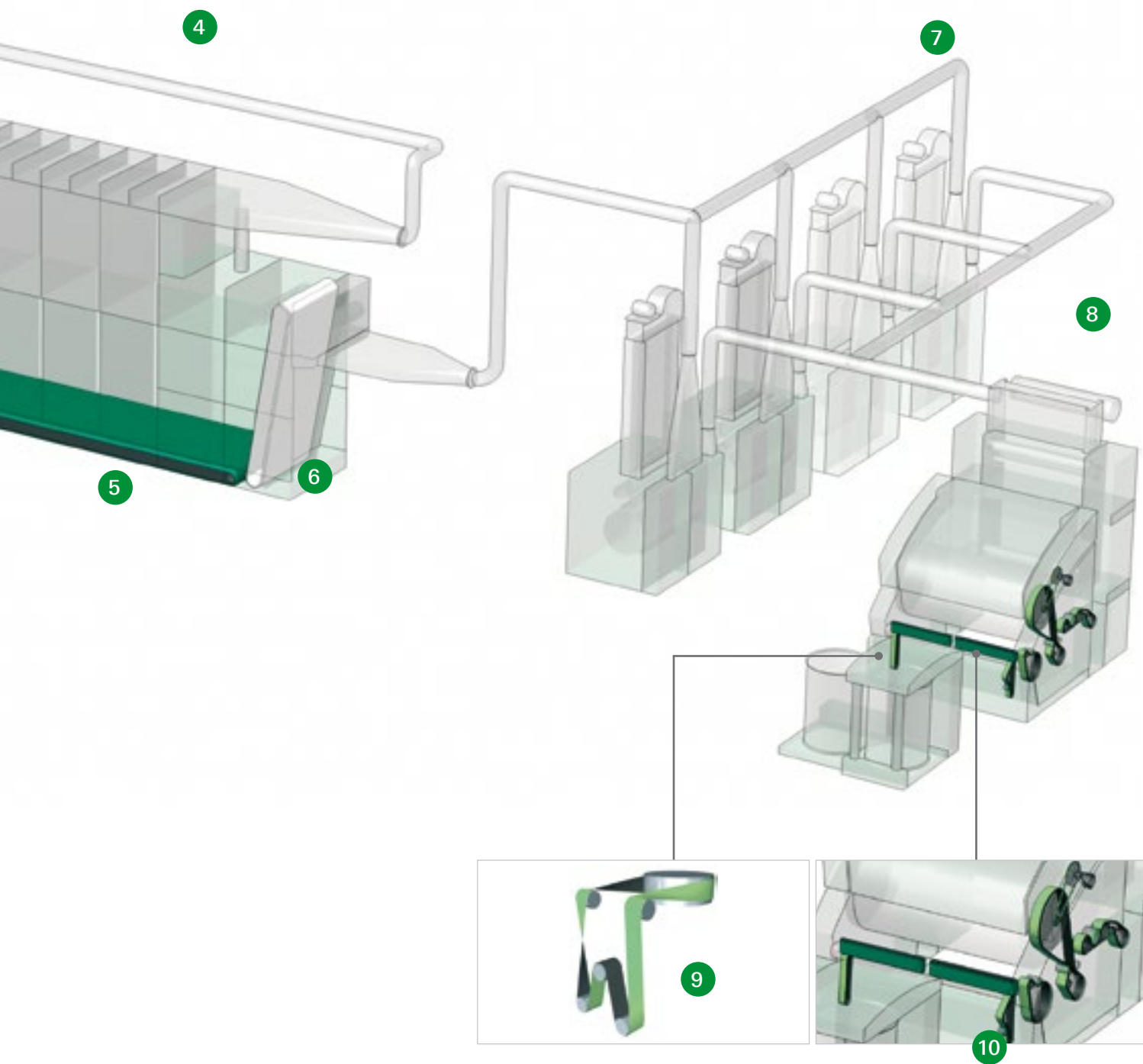

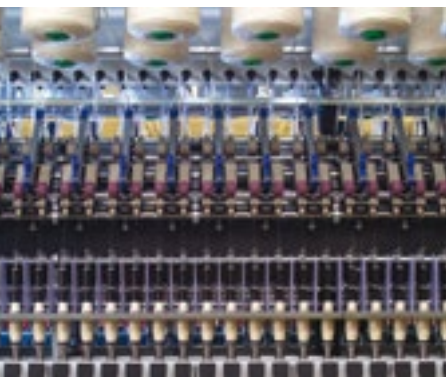
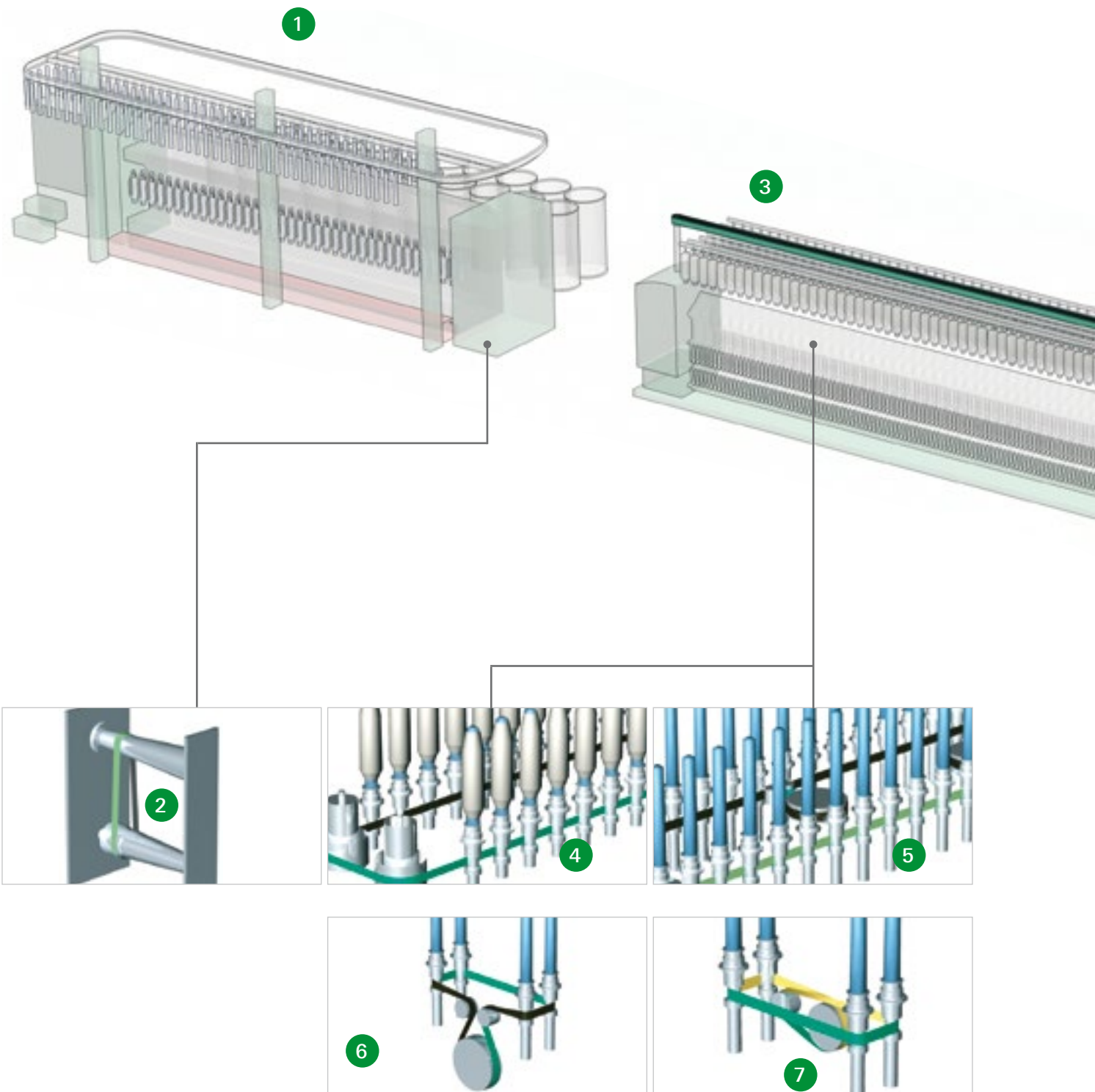

- | | |
|-------------------------|---|
| 1 Flyer (roving frame) | 6 Four-spindle drive (two jockey pulleys) |
| 2 Cone drive | 7 Four-spindle drive (one jockey pulley) |
| 3 Ring spinning frame | 8 Winder |
| 4 Tangential belt drive | 9 Drawing frame |
| 5 Group/selection drive | 10 Drawing frame |

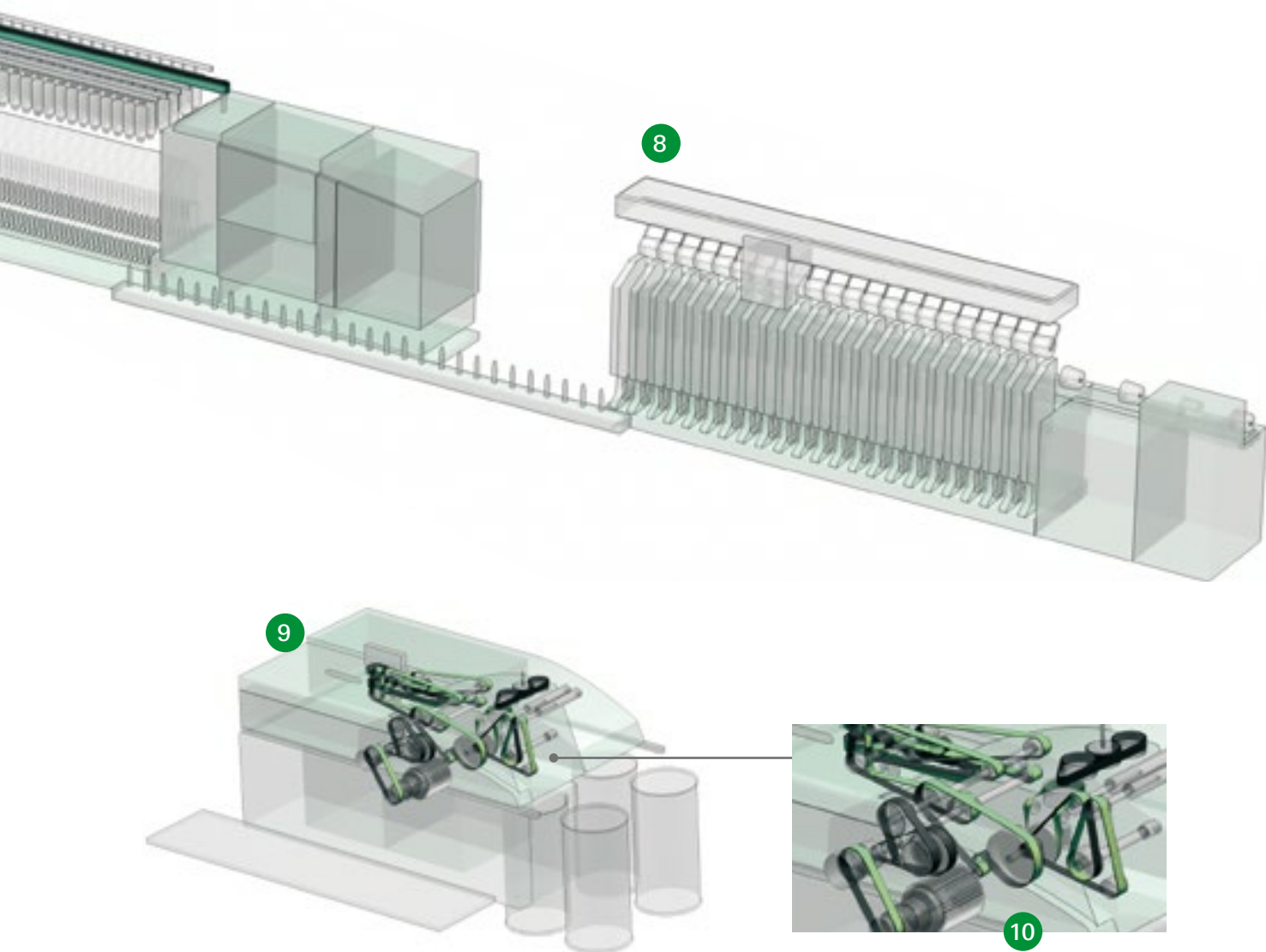

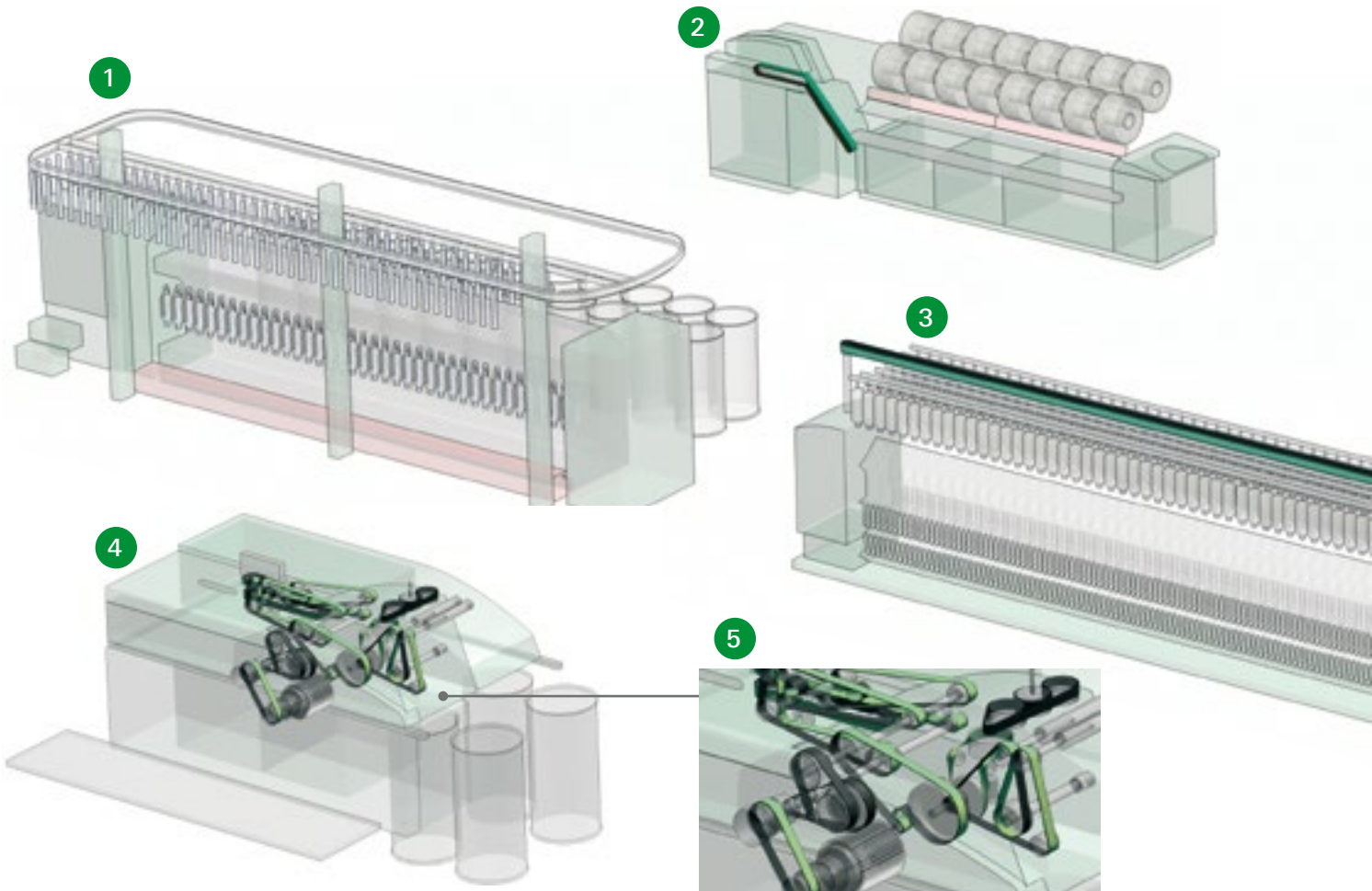

- | | |
|------------------------|------------------------|
| 1 Flyer (roving frame) | 6 Ribbon lap machine |
| 2 Comber | 7 Driving belt |
| 3 Ring spinning frame | 8 Winder |
| 4 Drawing frame | 9 Bobbin conveyor belt |
| 5 Drawing frame | 10 Winder |

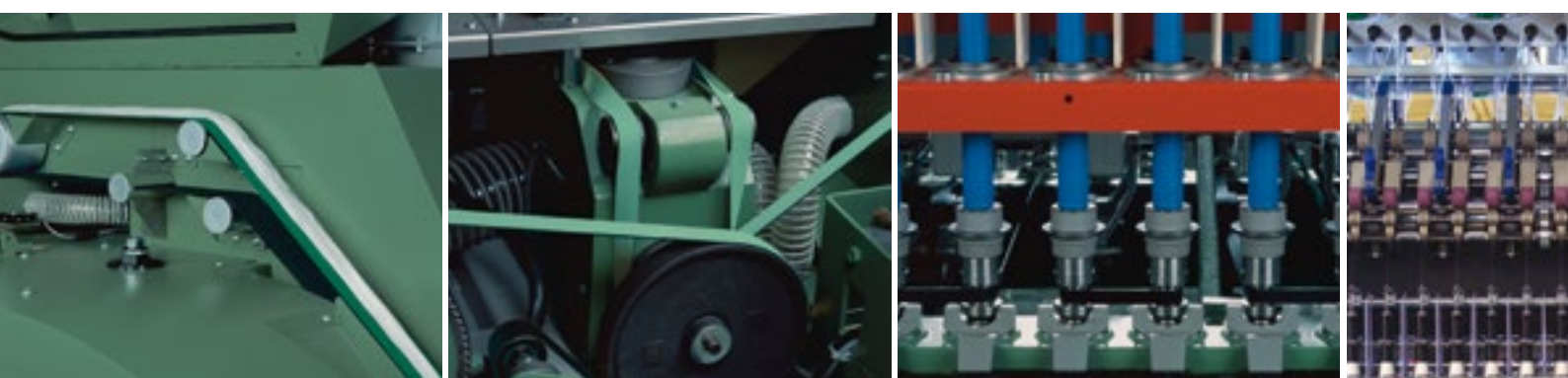

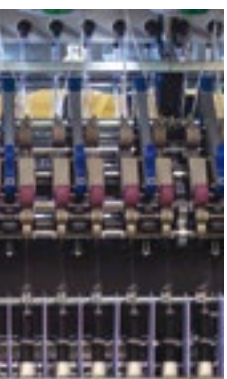
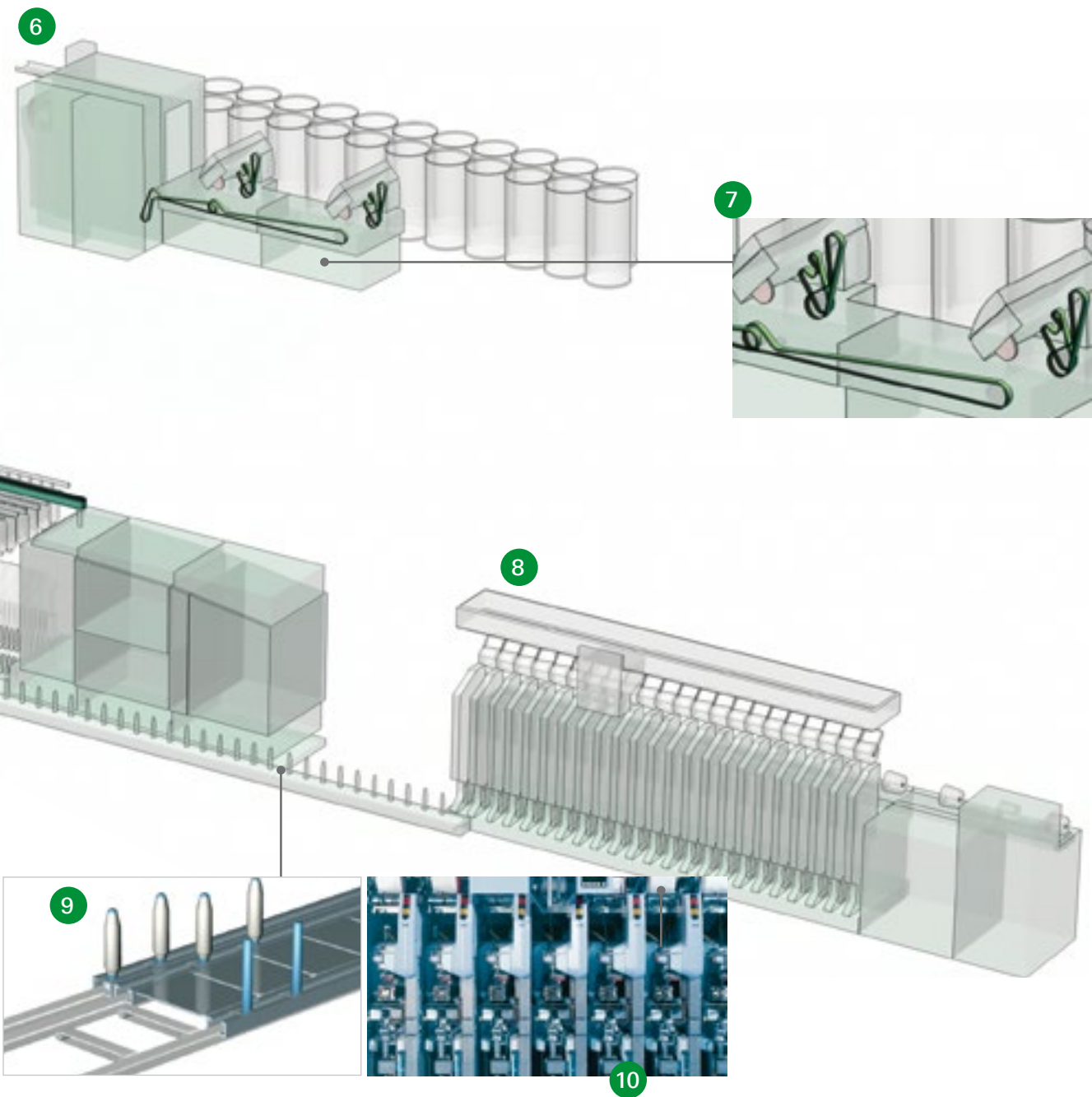

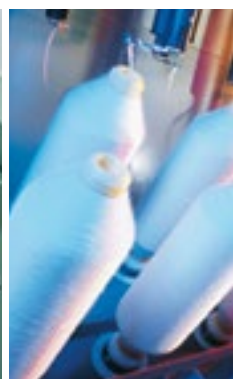
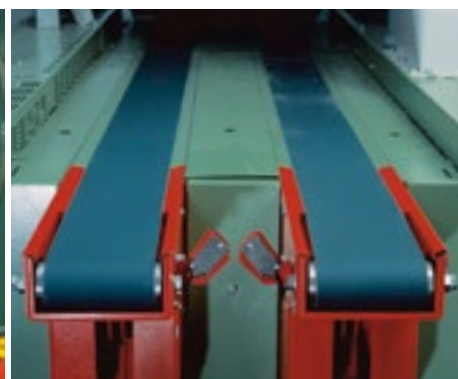
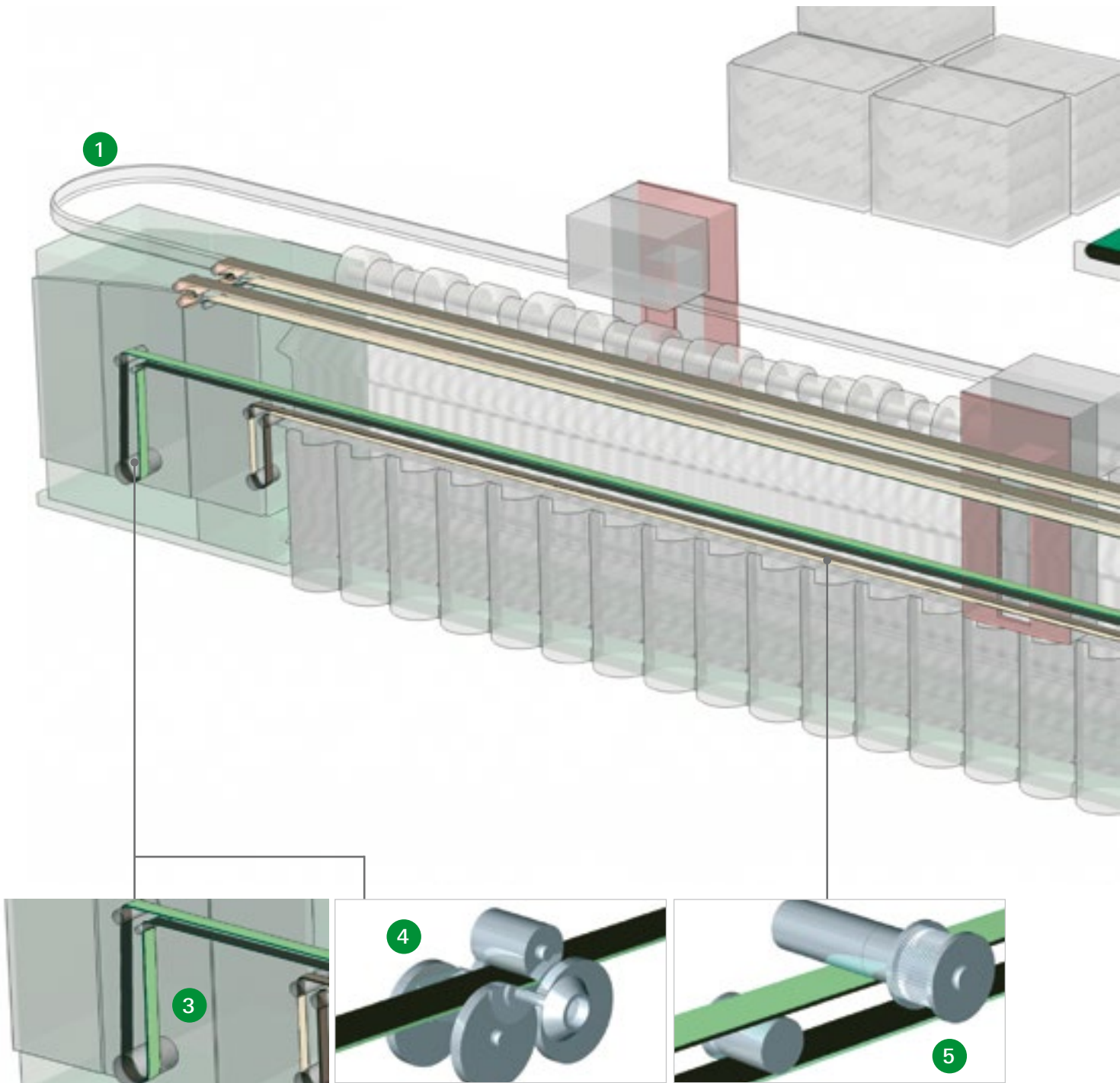

- 1 OE spinning
- 2 Conveyor belt
- 3 Rotor belt
- 4 OE drive
- 5 Combing roller belt
- 6 Bobbin conveyor belt
- 7 Main drive

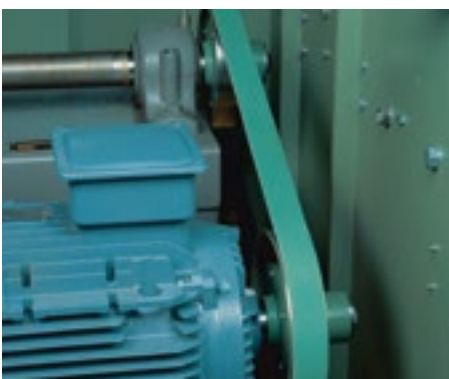
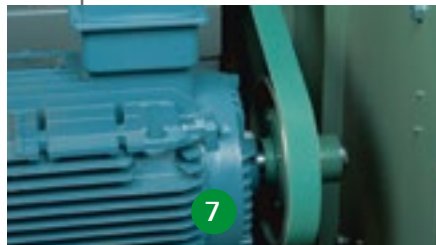
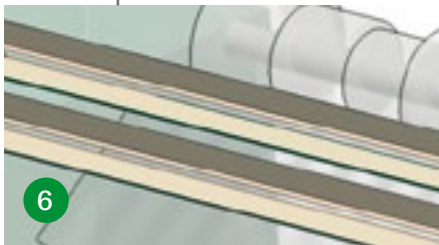
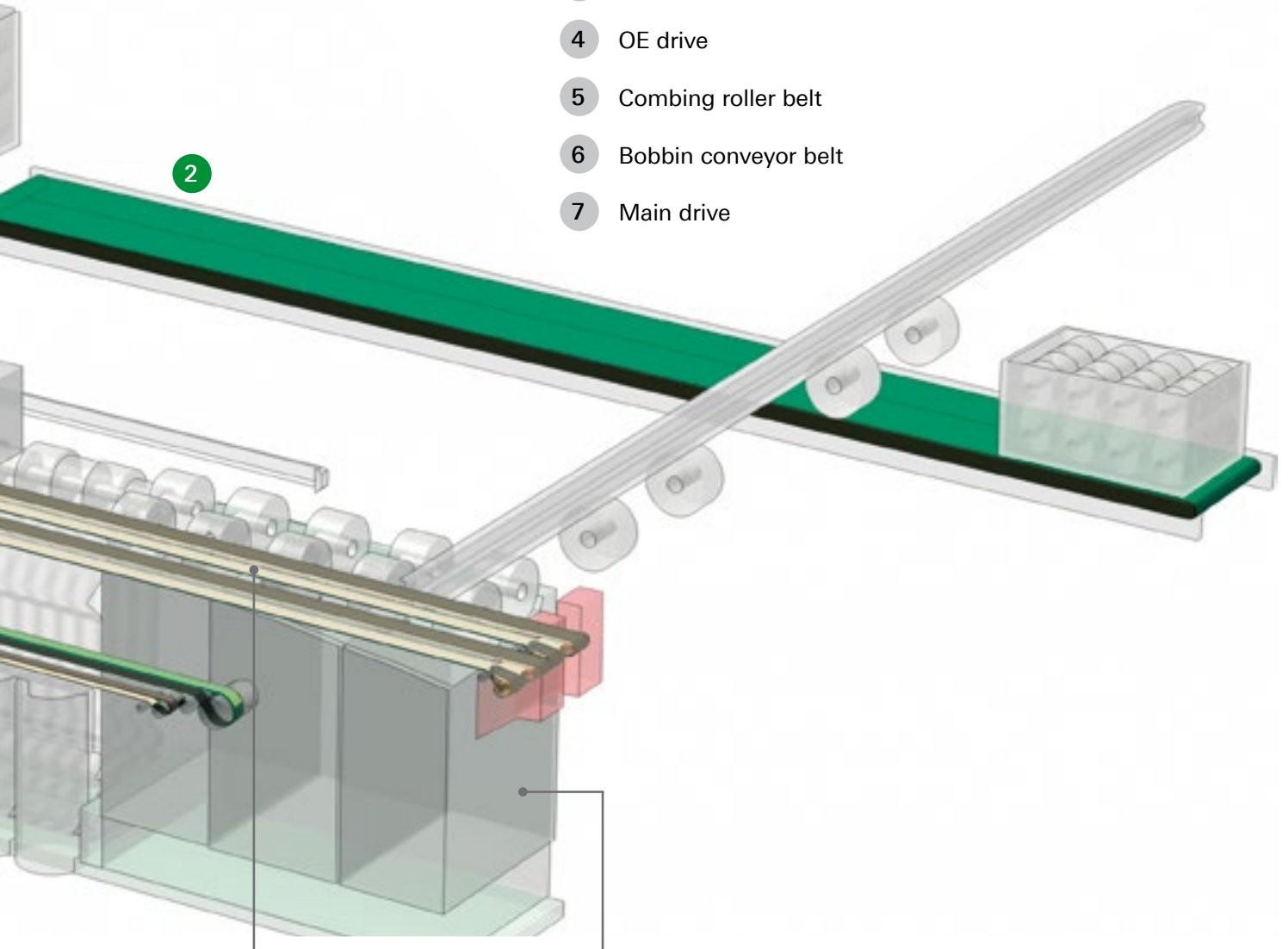

The right choice

Habasit has developed an extensive variety of different power transmission belts that allows you to choose the most suitable belt for your specific application requirements.

Belt cross section

TC-Polyester (PET) belts

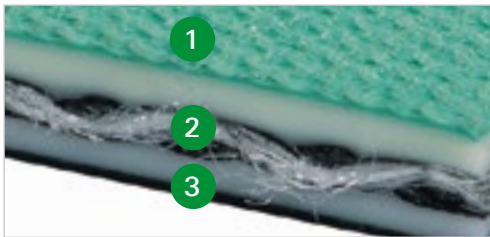

- 1 Light green, low aging and abrasion-resistant NBR rubber
- 2 Highly flexible polyester traction fabric with high modulus of elasticity
- 3 Black, antistatic, low aging NBR rubber

TF-Aramide (AR) belts

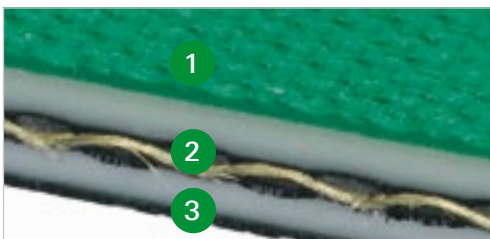

- 1 Green, low aging and abrasion-resistant NBR rubber
- 2 Highly flexible aramide traction fabric with the highest modulus of elasticity
- 3 Black, antistatic, low aging NBR rubber

S-Polyamide (PA) belts

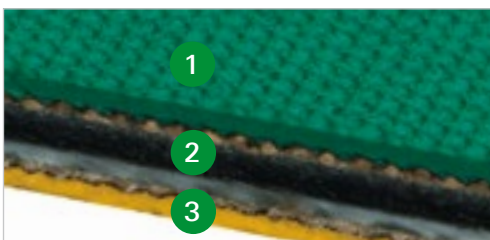

- 1 Low aging and abrasion-resistant NBR rubber
- 2 Highly stretched, resilient and dimensionally stable polyamide traction layer
- 3 Low aging and abrasion-resistant NBR rubber

Belt joining methods

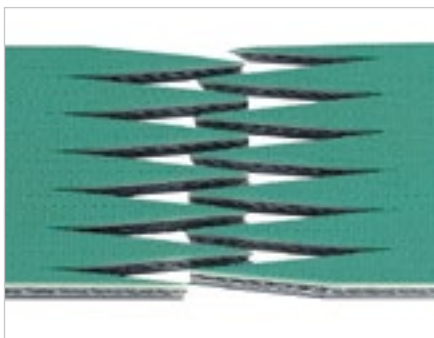

Flexproof

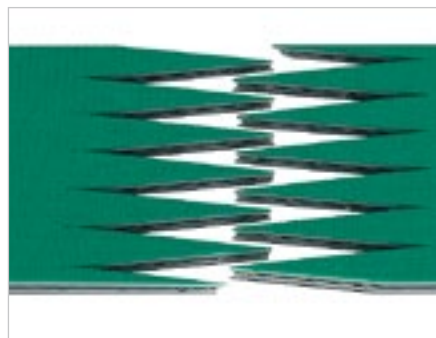

Flexproof



Thermofix

Polyamide power transmission belts (PA)

Polyamide power transmission belts from Habasit, the market leader, are found on spinning, twisting and texturing machines all over the world. They have an extremely long service life during which they guarantee consistently high power transmission.

We supply the required length and width on request, offering total freedom of design to engineers.

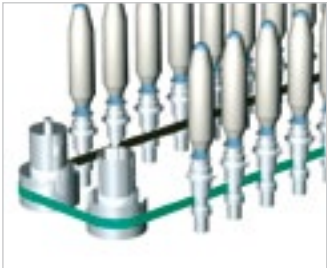

Key features	Your benefit
<ul style="list-style-type: none"> • Good dimensional stability 	<ul style="list-style-type: none"> • Long service life of the belt • Constant and uniform spindle rpm • High productivity
<ul style="list-style-type: none"> • Stable modulus of elasticity after running-in 	<ul style="list-style-type: none"> • No retensioning • No downtimes • No maintenance
<ul style="list-style-type: none"> • Two colors as installation aid 	<ul style="list-style-type: none"> • Easy insertion • No twisting of the belt • No installation errors • Short machine downtimes
<ul style="list-style-type: none"> • Forgiving 	<ul style="list-style-type: none"> • Belt can handle intermittent overloads • Process reliability • Long belt life

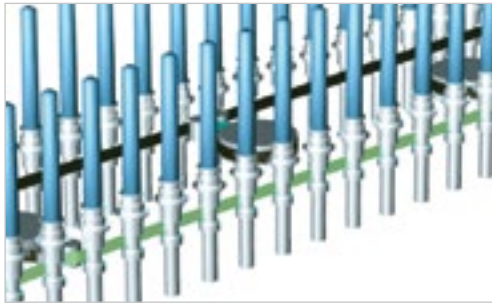

Polyester TC power transmission belts (PET)

Habasisit developed this unique product range through our close contacts with the textile industry, partnerships with leading machine manufacturers worldwide, and ongoing research. Habasisit has gained vast experience with polyester products in different industries and applications over the years. The result is an energy-saving product range with a perfect price/value ratio and outstanding performance.

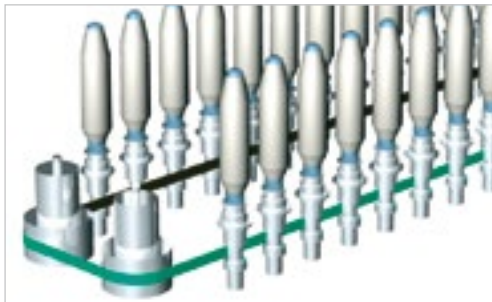

Aramide power transmission belts (AR)

TF tangential/flat belts are used for future-oriented and extremely compact driving configurations at very high speeds. Aramide power transmission belts are popular in the market due to their high efficiency, energy-saving features, and high power transmission. They run at a very low initial working tension with little noise. Aramide belts have greater dimensional stability, which saves time during installation, reduces maintenance work, and guarantees a long service life for the belt.

Key features	TC	TF	Your benefit
<ul style="list-style-type: none"> • Low energy consumption 	•	•	<ul style="list-style-type: none"> • Energy and cost savings • Energy consumption reduced by 4% to 6% • Efficient production • Good price/value ratio • Reduced operating costs • Maximum efficiency
<ul style="list-style-type: none"> • Two colors as installation aid • Simple and fast joining • Adhesive-free joining method 	•	•	<ul style="list-style-type: none"> • Easy handling • Short machine downtimes • Minimum equipment required
<ul style="list-style-type: none"> • Reliable and homogeneous joining quality 	•	•	<ul style="list-style-type: none"> • High spindle speeds (rpm) • No vibration • Consistent yarn quality
<ul style="list-style-type: none"> • TC range: high elastic modulus 	•		<ul style="list-style-type: none"> • High accuracy of spindle rpm • Consistent yarn quality
<ul style="list-style-type: none"> • TF range: top-grade elastic modulus 		•	<ul style="list-style-type: none"> • Highest accuracy of spindle rpm even with very long belts • Consistent yarn quality
<ul style="list-style-type: none"> • Very flexible belt 	•	•	<ul style="list-style-type: none"> • Excellent flex-fatigue properties • Longest service life • Outstanding reliability • Suitable for small pulley diameters



Energy savings with Habasit TC tangential belts compared with competitors' polyamide belts

Compare the energy cost-saving potential of Habasit polyester TC and TF tangential belts with competitors' polyamide tangential belts.

Your savings

Average energy-saving potential in percentage of power to be transmitted	4% to 6%
Average energy cost-saving potential per spindle/year	~ USD 1
Average energy cost-saving potential per year in a spinning mill with around 200,000 spindles	~ USD 200,000

Energy consumption comparisons – showing savings

Examples from India

Energy consumption comparison between competitor polyamide tangential belts and Habasit polyester TC tangential belts. Made on Leewha TFO two-for-one twisters at Rajasthan Spinning & Weaving Mills Ltd. in India:

	Example 1		Example 2	
	Competitor polyamide belt	Habasit TC-35ER belt	Competitor polyamide belt	Habasit TC-35/30ER belt
Spindle speed (rpm)	9,100 rpm		10,100 rpm	
Consumed energy	24.32 kWh	22.82 kWh	23.3 kWh	22.3 kWh
Energy savings with Habasit TC belts		6.2%		4.3%

Examples from China

Energy consumption comparison between competitor polyamide tangential belts and Habasit polyester TC tangential belts. Made on Zhejiang Weifeng WF-168 covering machines (840 spindles) in China:

	Example 1		Example 2	
	Yiwu Hangfei Covering Yarn Co. Ltd.		Shantou Covering Yarn Factory	
Energy savings per machine and day	24 kWh		21 kWh	
Average working days per year	300		360	
Energy costs per kWh	CNY 0.7	USD 0.11	CNY 0.7	USD 0.11
Energy cost-savings per machine and year	CNY 5,040	USD 792	CNY 5,292	USD 832
Number of machines installed	275		250	
Number of spindles per machine	840		840	
Total energy savings per year	CNY 1,386,000	USD 217,800	CNY 1,323,000	USD 207,900
Energy savings per year and spindle	CNY 6.00	USD 0.94	CNY 6.3	USD 0.99

Energy savings with HabaDRIVE® power transmission belts

Energy savings with Habasit TC and TF flat belt drives compared with V-belt drives

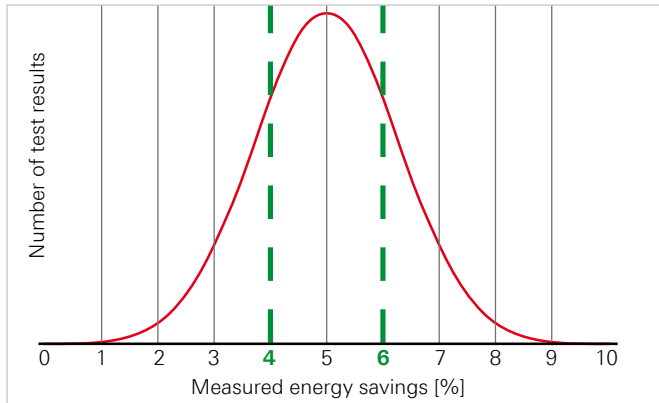

For peripheral equipment and plant infrastructure (e.g. fans, compressors, vacuum pumps, blowers, etc.)

Habasit also provides optimized driving belt solutions. Conversion campaigns at over 2,000 sites have demonstrated that switching from V-belts to Habasit's flat belts reduces energy consumption by **4% to 6%**.

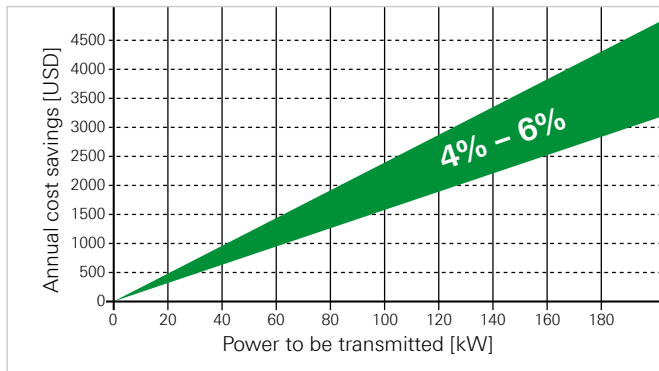

Check your approximate energy cost-saving potential

Assumption:
12 h/day
330 days/year
0.10 USD/kWh



Energy savings on fan drives

The energy-saving properties of the flat belt drive compared to the V-belt drive have been proved during practical tests.

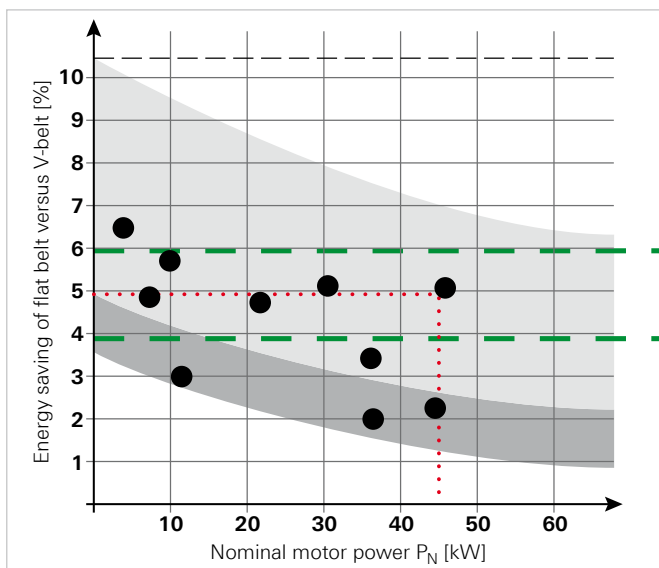

The illustration indicates the saved energy as a percentage, depending on the nominal power of the installed motor.

- Partial load range
- Rated load (full load) range

Example (red dotted line):

Energy saving of a fan drive equipped with flat belts on a 45 kW motor:

- at rated load (full load) about 2%
- at partial load about 5%

As electric motors usually work at partial load, the energy-saving potential of a flat belt drive is considerable.

Average: 4% to 6% energy savings.

The right choice

Habasit has developed an extensive variety of spindle tapes that allows you to choose the most suitable tape for your specific application requirements.

Belt cross section

W- and DS- Polyester (PET) spindle tapes



- 1 Green impregnated polyester traction fabric (whirl side)
DS-8: white fabric)
- 2 Black, antistatic, thermoplastic friction cover (driving pulley side)

TS-/HS- Polyamide (PA) spindle tapes

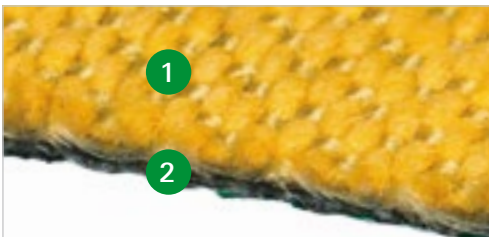

- 1 Yellow polyamide traction fabric (whirl side)
- 2 Green NBR rubber friction cover (driving pulley side)



W-8/DS-8 four-spindle drive with two jockey pulleys

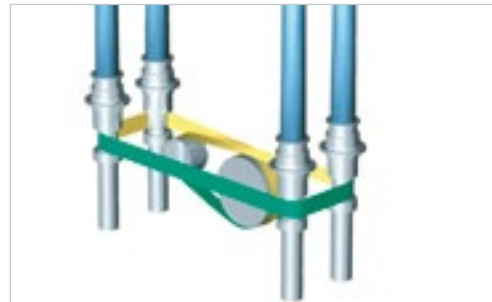

TS/HS four-spindle drive with one jockey pulley

Belt joining methods

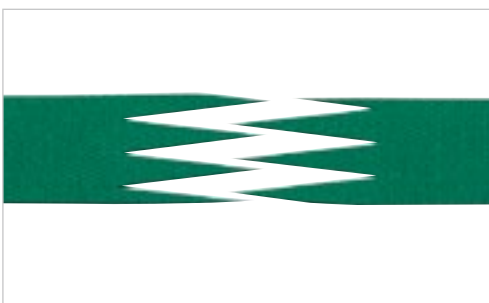

Flexproof (finger geometry 5.5x35 mm)



Thermofix

Polyester spindle tapes (PET)

Habasit W-spindle tapes were developed in intensive cooperation with leading OEMs and EUs. The main focus was suitability for spindle speeds (rpm) over 20,000 rpm, no fiber fly accumulation, as well as a long and reliable service life. These development goals were all achieved, which is why leading machine manufacturers in Switzerland, Japan, China and India today use W- and DS-spindle-tapes for their original equipment.



Key features	Your benefit
<ul style="list-style-type: none"> • Low energy consumption • Excellent flex-fatigue properties 	<ul style="list-style-type: none"> • Suitable for highest spindle rpm • (> 20,000 rpm) • Long service life • Cost savings
<ul style="list-style-type: none"> • Minimized speed loss during spindle stop 	<ul style="list-style-type: none"> • Uniform yarn quality • Increased efficiency • Cost savings
<ul style="list-style-type: none"> • Simple and fast joining method (Flexproof) • Adhesive-free joint 	<ul style="list-style-type: none"> • Easy handling • Short machine downtimes • S and Z direction possible
<ul style="list-style-type: none"> • No fiber accumulation 	<ul style="list-style-type: none"> • Constant spindle speed (rpm) • No need for cleaning • No interruption of production • Uniform yarn quality

Polyamide spindle tapes (PA)

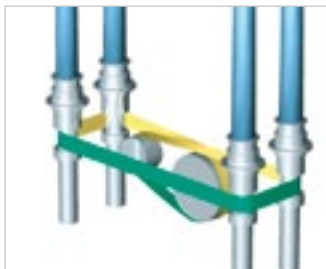

Key features	Your benefit
<ul style="list-style-type: none"> • Robust tape 	<ul style="list-style-type: none"> • Long service life
<ul style="list-style-type: none"> • Good price/value ratio 	<ul style="list-style-type: none"> • Efficient production • Cost savings
<ul style="list-style-type: none"> • No fiber accumulation 	<ul style="list-style-type: none"> • Constant spindle speed (rpm) • No need for cleaning • No interruption of production • Uniform yarn quality



Saving energy

Saving energy is an important issue for the textile industry today, as power requirements are continuously increasing due to high-speed operations. The ring spinning frame is a major consumer of energy, taking 40% to 60% of total spinning mill energy consumption.

Of this, one third of the power is used to drive the spindles. Spinning mill power costs currently account for about 12% to 18% of the total cost of production.

As a result, saving energy with the spindle tape has become even more vital in the spinning industry. Studies conducted by a leading research institute in South India on modern ring spinning frames at higher spindle speeds (rpm) have shown convincing results.

Proven in field tests

Field tests at reputed spinning mills have confirmed that the replacement of polyamide spindle tapes with the highly efficient Habasit polyester W-8 or DS-8 spindle tapes provide **substantial energy and cost savings**.



Customers first

Your success is our goal. That is why we don't just offer products; we provide solutions. As committed partners to our customers, we are dedicated to sharing our knowledge and providing full support.

Since our founding in 1946, Habasit has been finding ways to meet customer-specific needs in every application. This is what differentiates us as the #1 worldwide belting provider in the industry today.



Comprehensive consulting and technical support

Profit from the best consulting and technical support in the lightweight belting industry. Local experts are always available to assist you with your belting needs. The Habasit team is proud to provide the highest level of support, together with top-quality products that have led the global market for decades.



Belt selection and calculation assistance

We are always glad to help you select the most suitable belt for any application for your convenience. We now also provide the free online tool 'SeleCalc' which allows you to easily make selections and calculations yourself. Simply register online at selecalc.habasit.com.



Fabrication, assembly and local installation services

As a full-service belting provider, we offer joining and assembly services either at our own locations or directly on your equipment.

Habasit has over 30 affiliates worldwide, each with its own inventory, fabrication, assembly and service facilities.



Together with representative offices and numerous qualified distributors, we can react quickly and efficiently to meet all your needs.



Customer training programs

To ensure the optimal performance and maximum lifespan of all our products, we offer training programs and various support tools. This includes proper procedures for fabrication, installation, assembly, maintenance and belt repair, all of which take place at a Habasit site or at your location.

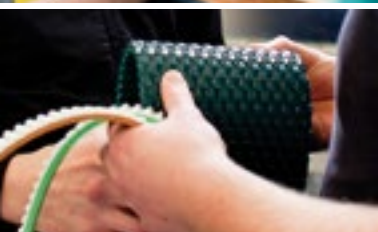

Belt monitoring, inspections, analyses and process optimization proposals

We organize and handle belt maintenance, inspections, analyses and surveys at customers' sites. Upon request, we are ready to develop optimization proposals to ensure you're getting maximum value from your machinery and process output.



Design assistance for customized solutions

Habasit believes in building partnerships with our customers. Our engineering team will work closely with your engineers on joint design developments from initial design to final implementation. This expert service can be invaluable for projects involving new technologies or large-scale modifications and adaptations.



Committed to innovation

Because our customers' belting challenges and needs are always changing, we consistently invest a substantial amount of labor and resources into the research and development of new products and solutions.

Certified for quality

We deliver the highest quality standards not only in our products and solutions, but also in our employees' daily work processes. Habasit AG is certified according to ISO 9001:2015.



Worldwide leading product range

Habasit offers the largest selection of belting, conveying, processing and complementary products in the industry. Our response to any request is nothing less than a specific, tailor-made solution.



HabaFLOW®
Fabric-based conveyor and processing belts

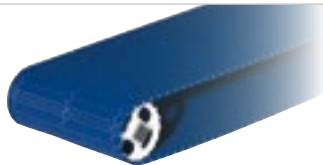

HabasitLINK®
Plastic modular belts

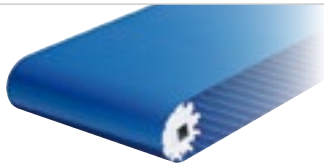

Habasit® Cleandrive
Monolithic reinforced conveyor belts



HabaDRIVE®
Power transmission belts

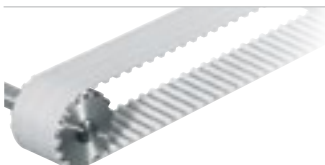

HabaSYNC®
Timing belts



HabasitCHAIN®
Chains (slat and conveyor chains)



Machine tapes

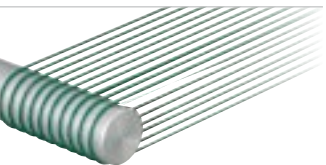

Round belts



Seamless belts



HabiPLAST
Profiles, Guides, Wear strips



Accessories
(sprockets, flights, welding profiles, etc.)



Fabrication tools
(joining, cutting & preparing devices)

Australia

Habasit Australia Pty Ltd.
Silverwater, Sydney
Phone: +61 1300 945 455
www.habasit.com.au

Austria

Habasit GmbH, Wiener Neudorf
Phone: +43 1 690 66
www.habasit.at

Belgium & Luxembourg

Habasit Belgium N.V., Zaventem
Phone: +32 27 250 430
www.habasit.be | habasit.lu

Brazil

Habasit do Brasil, Barueri - SP
Phone: +55 11 4789 9022
www.habasit.com.br

Canada

Habasit Canada Ltd., Oakville
Phone: +1 905 827 41 31
www.habasit.ca

China

Habasit East Asia Ltd.
Fotan, Shatin, N.T., Hong Kong
Phone: +852 2145 0150
www.habasit.com.hk

Habasit (Shanghai) Co. Ltd.
Shanghai
Phone: +8621 5488 1218
www.habasit.com.cn

France

Habasit France SAS, Mulhouse
Phone: +33 3 89 33 89 03
www.habasit.fr

Germany

Habasit GmbH, Eppertshausen
Phone: +49 6071 969 0
www.habasit.de

India

Habasit India, Coimbatore
Phone: +91 422 666 78 00
www.habasit.in

Italy

Habasit Italiana SpA
Customer Care: 0438 911333
For int. calls: +39 0438 911444
www.habasit.it

Japan

Habasit Nippon Co., Ltd., Tokyo
Phone: +81 120 07 6339
www.habasit.co.jp

Korea (Republic of)

Habasit Korea Ltd., Seongnam
Phone: +82 31 737 9370
www.habasit.co.kr

Mexico

Habasit Rocua, Zapopan
Phone: +52 33 3824 2358
www.habasitrocu.mx

Netherlands

Habasit Netherlands BV, Nijkerk
Phone: +31 332 472 030
www.habasit.nl

New Zealand

Habasit New Zealand Pty Ltd.
Auckland
Phone: 0800 000 070
www.habasit.co.nz

Nordic countries

Habasit AB, Hindås, Sweden
Phone: +46 301 226 00
www.habasit.se

Poland

Habasit Polska Sp. z o.o.
Dąbrowa Górnicza
Phone: +48 32 639 02 40
www.habasit.pl

Russia

OOO Habasit Ltd.
Moscow Region
Phone: +7 495 966 1566
www.habasit.ru

Singapore

Habasit Far East Pte Ltd.
Singapore
Phone: +65 6862 5566
www.habasit.com.sg

South Africa

Habasit South Africa Pty Ltd.
Gauteng
Phone: +27 10 001 6770
www.habasit.co.za

Spain

Habasit Hispánica S.A.
Barberá del Vallés
Phone: +34 937 191 912
www.habasit.es

Switzerland

Habasit GmbH, Reinach
Phone: +41 61 577 51 00
www.habasit.ch

Taiwan

Habasit (Taiwan) Ltd.
New Taipei City
Phone: +886 2 2267 0538
www.habasit.com.tw

Turkey

Habasit Kayis San.
Ve Tic. Ltd. Sti., Istanbul
Phone: +90 444 70 43
www.habasit.com.tr

Ukraine

Habasit Ukraine LLC., Kyiv
Phone: +38 044 290 88 99
www.habasit.ua

United Kingdom & Ireland

Habasit UK Ltd., Elland
Phone: +44 333 207 6570
www.habasit.co.uk

USA

Habasit America
Suwanee, Georgia
Phone: +1 800 458 6431
www.habasitamerica.com

Habasit International AG

Römerstrasse 1
CH-4153 Reinach, Switzerland
Phone +41 61 715 15 15
Fax +41 61 715 15 55
www.habasit.com

Registered trademarks
Copyright Habasit International AG
Subject to alterations
2006BRO.TEX-en0519HQ